

Standard Recovery Diodes (Hockey PUK Version), 2060A

FEATURES

- Wide current range
- High voltage ratings up to 4500V
- High surge current capabilities
- Diffused junction
- Hockey PUK version
- Case style DO-220AC(K-PUK), Nell's D-type Capsule
- Lead (Pb)-free

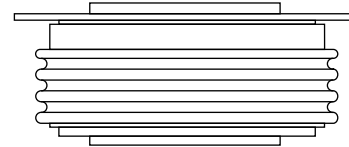

DO-200AC(K-PUK)
(Nell's D-type Capsule)

TYPICAL APPLICATIONS

- Converters
- Power supplies
- Machine tool controls
- High power drives
- Medium traction applications

PRODUCT SUMMARY	
$I_{F(AV)}$	2060A

MAJOR RATINGS AND CHARACTERISTICS			
PARAMETER	TEST CONDITIONS	VALUES	UNIT
$I_{F(AV)}$		2060	A
	T_{hs}	55	°C
$I_{F(RMS)}$		3750	A
	T_{hs}	25	°C
I_{FSM}	50 HZ	20000	A
	60 HZ	20940	
I^2t	50 HZ	2000	kA ² s
	60 HZ	1820	
V_{RRM}		2600 to 4500	V
T_J	Typical	-40 to 150	°C

ELECTRICAL SPECIFICATIONS

VOLTAGE RATINGS				
TYPE NUMBER	VOLTAGE CODE	V_{RRM} , MAXIMUM REPETITIVE PEAK REVERSE VOLTAGE V	V_{RSM} , MAXIMUM NON-REPETITIVE PEAK REVERSE VOLTAGE V	I_{RRM} , MAXIMUM AT $T_J = T_J$ MAXIMUM mA
D2060D	26	2600	2700	70
	30	3000	3100	
	36	3600	3700	
	40	4000	4100	
	45	4500	4600	

FORWARD CONDUCTION					
PARAMETER	SYMBOL	TEST CONDITIONS		VALUES	UNIT
Maximum average forward current at heatsink temperature	$I_{F(AV)}$	180° conduction, half sine wave Double side (single side) cooled		2060(1000)	A
				55(85)	°C
Maximum RMS forward current	$I_{F(RMS)}$	25°C heatsink temperature double side cooled		3750	A
Maximum peak, one cycle non-repetitive surge current	I_{FSM}	t = 10ms	No voltage reapplied	Sinusoidal half wave, initial $T_J = T_J$ maximum	A
		t = 8.3ms			
		t = 10ms	50% V_{RRM} reapplied		
		t = 8.3ms			
Maximum I^2t for fusing	I^2t	t = 10ms	No voltage reapplied	Sinusoidal half wave, initial $T_J = T_J$ maximum	kA ² s
		t = 8.3ms			
		t = 10ms	50% V_{RRM} reapplied		
		t = 8.3ms			
Maximum $I^2\sqrt{t}$ for fusing	$I^2\sqrt{t}$	t = 0.1 to 10 ms, no voltage reapplied		20000	kA ² √s
Low level value of threshold voltage	$V_{F(TO)1}$	$(16.7\% \times \pi \times I_{F(AV)} < I < \pi \times I_{F(AV)})$, $T_J = T_J$ maximum		0.88	V
High level value of threshold voltage	$V_{F(TO)2}$	$(I > \pi \times I_{F(AV)})$, $T_J = T_J$ maximum		1.00	
Low level value of forward slope resistance	r_{t1}	$(16.7\% \times \pi \times I_{F(AV)} < I < \pi \times I_{F(AV)})$, $T_J = T_J$ maximum		0.30	mΩ
High level value of forward slope resistance	r_{t2}	$(I > \pi \times I_{F(AV)})$, $T_J = T_J$ maximum		0.27	
Maximum forward voltage drop	V_{FM}	$I_{pk} = 4000A$, $T_J = T_J$ maximum, $t_p = 10$ ms sinusoidal wave		2.15	V

THERMAL AND MECHANICAL SPECIFICATIONS					
PARAMETER	SYMBOL	TEST CONDITIONS		VALUES	UNIT
Maximum junction operating temperature range	T_J			-40 to 150	°C
Maximum storage temperature range	T_{stg}			-55 to 200	
Maximum thermal resistance, junction to heatsink	R_{thJ-hs}	DC operation single side cooled		0.042	K/W
		DC operation double side cooled		0.020	
Mounting force, ±10%				22250 (2250)	N (kg)
Approximate weight				425	g
Case style		TO-200AC (K-PUK), Nell's D-type Capsule			

△ R_{thJC} CONDUCTION						
CONDUCTION ANGEL	SINUSOIDAL CONDUCTION		RECTANGULAR CONDUCTION		TEST CONDUCTIONS	UNITS
	SINGLE SIDE	DOUBLE SIDE	SINGLE SIDE	DOUBLE SIDE		
180°	0.002	0.002	0.001	0.001	$T_J = T_J$ maximum	K/W
120°	0.002	0.002	0.002	0.002		
90°	0.003	0.003	0.003	0.003		
60°	0.004	0.004	0.004	0.004		
30°	0.007	0.007	0.007	0.007		

Note

- The table above shows the increment of thermal resistance R_{thJ-hs} when devices operate at different conduction angles than DC

Fig.1 Current ratings characteristics

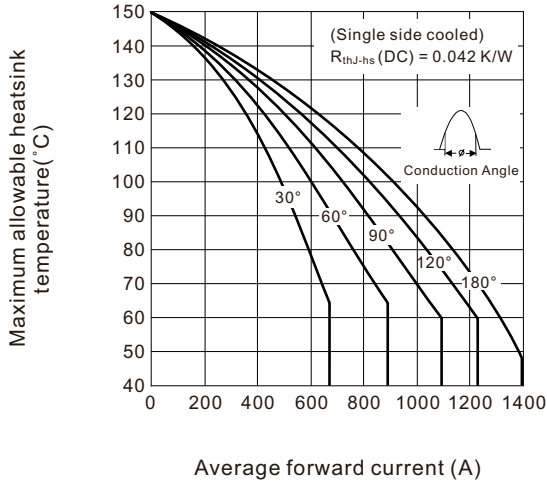

Fig.2 Current ratings characteristics

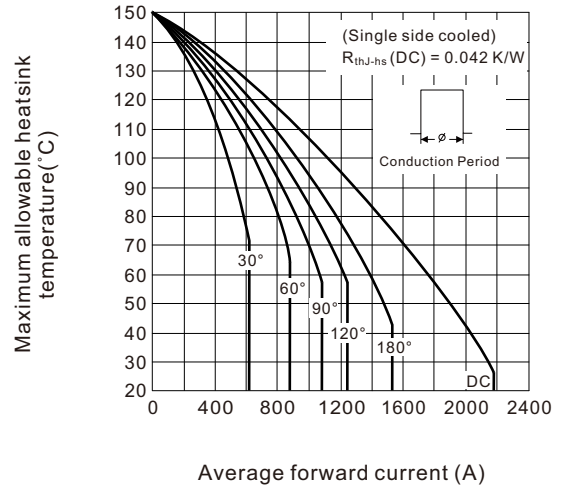

Fig.3 Current ratings characteristics

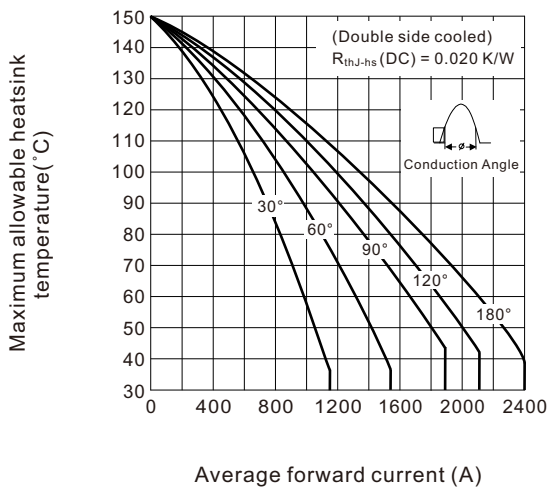

Fig.4 Current ratings characteristics

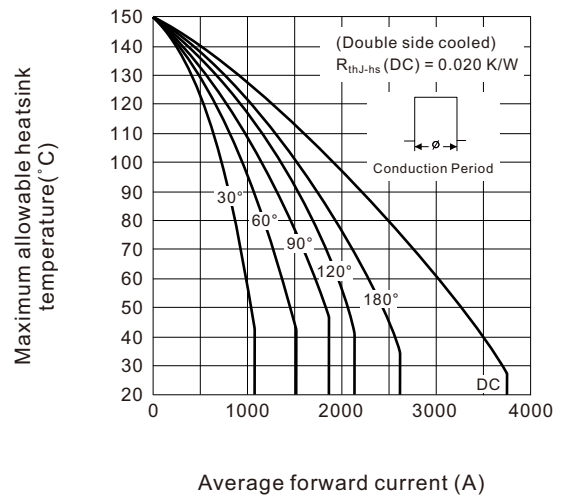

Fig.5 Forward power loss characteristics

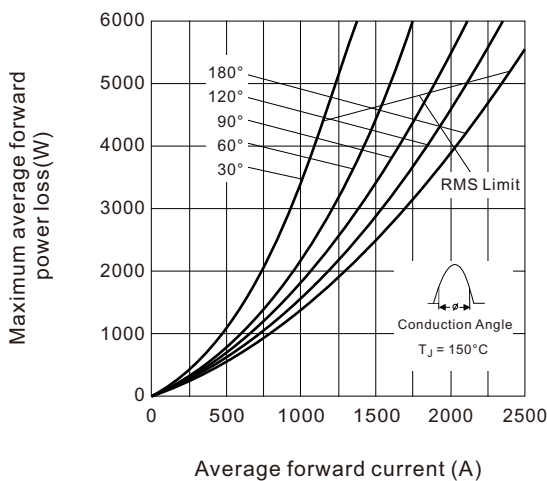

Fig.6 Forward power loss characteristics

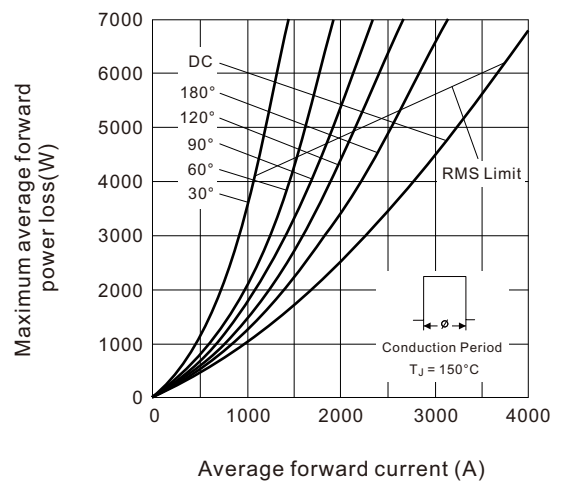

Fig.7 Maximum non-repetitive surge current single and double side cooled

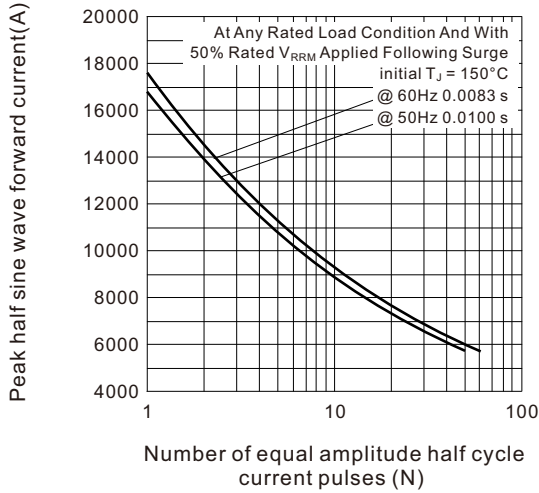

Fig.8 Maximum non-repetitive surge current single and double side cooled

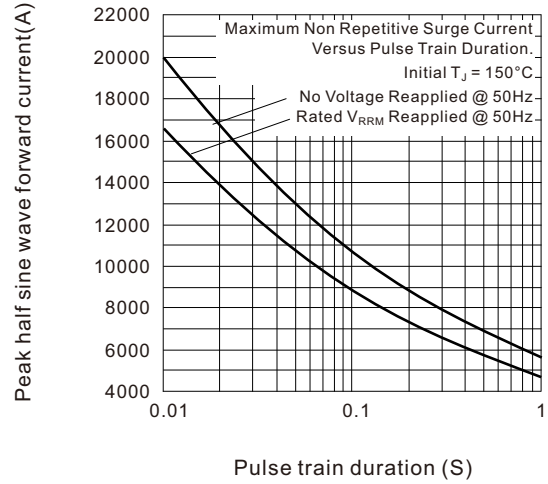

Fig.9 Forward voltage drop characteristics

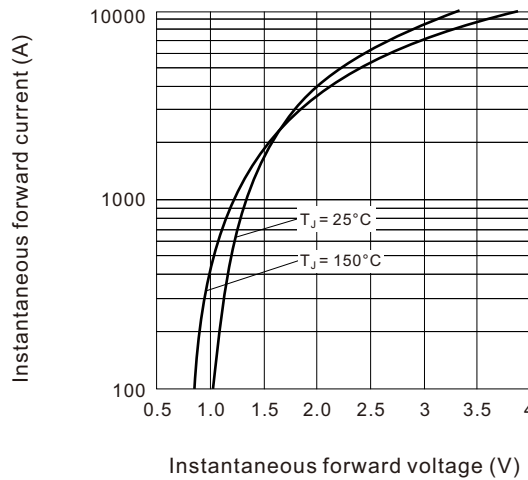
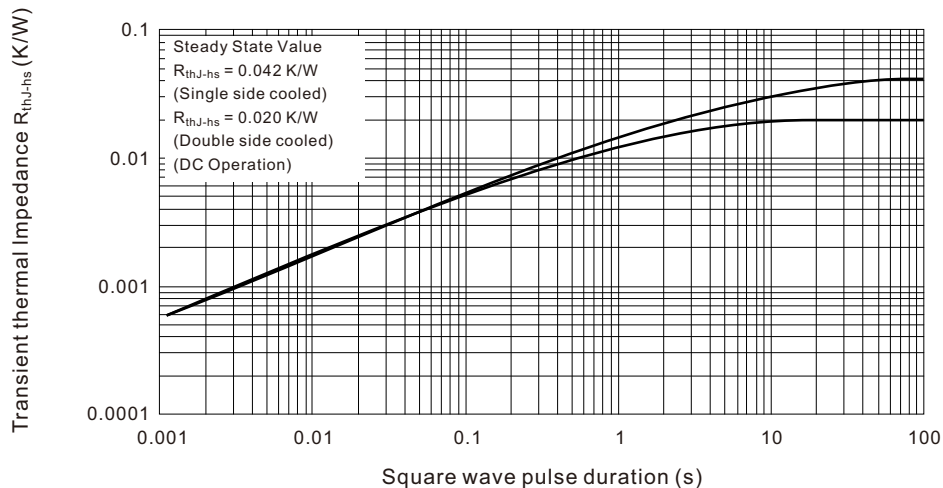
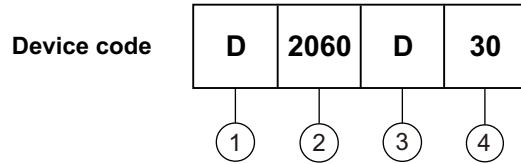

Fig.10 Thermal Impedance R_{thJ-hs} characteristics



ORDERING INFORMATION TABLE



- ① - "D" for standard recovery diode
- ② - Maximum average forward current, "2060" for 2060A
- ③ - Case style : "D" for Nell's D-type Capsule, DO-200AC (K-PUK)
- ④ - Voltage code, code x 100 = V_{RRM}

DO-220AC (K-PUK), Nell's D-type Capsule

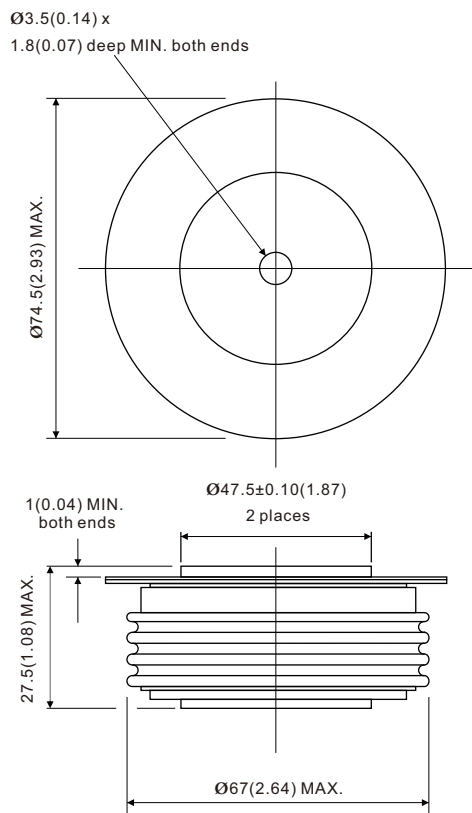

All dimensions in millimeters (inches)

